

50

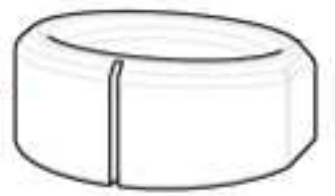

51

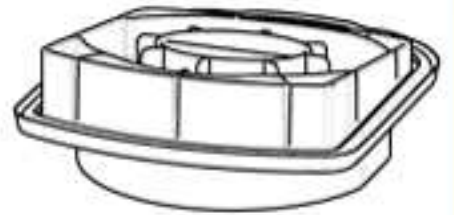

52

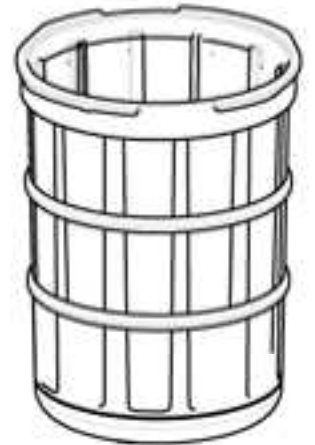
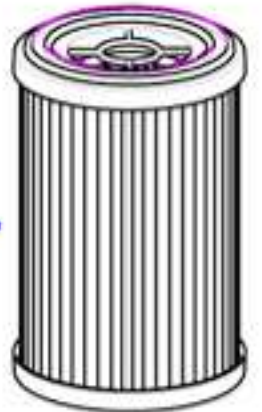

53

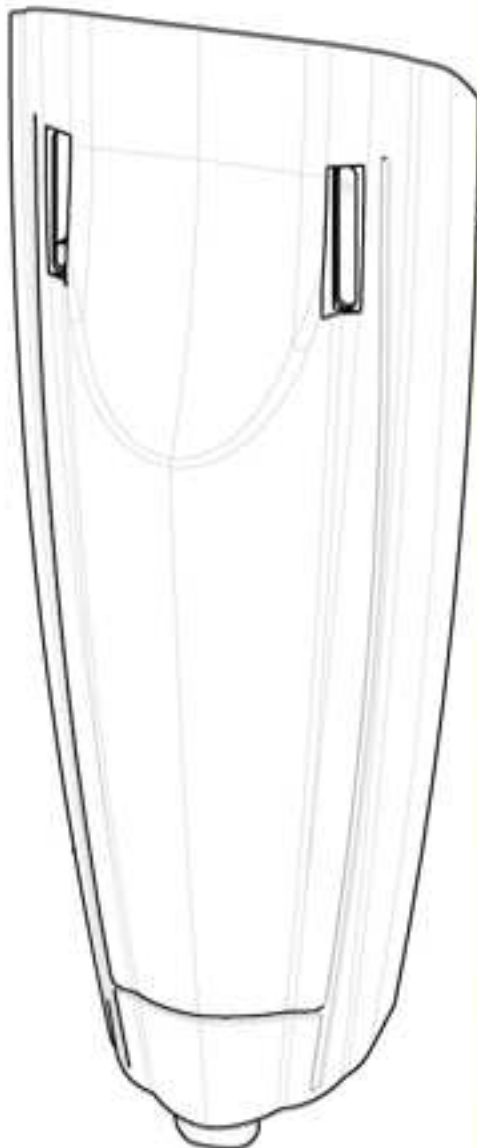
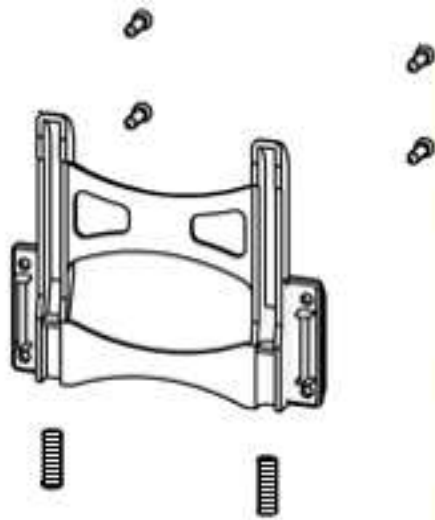

101



102



103





400



401



402



403

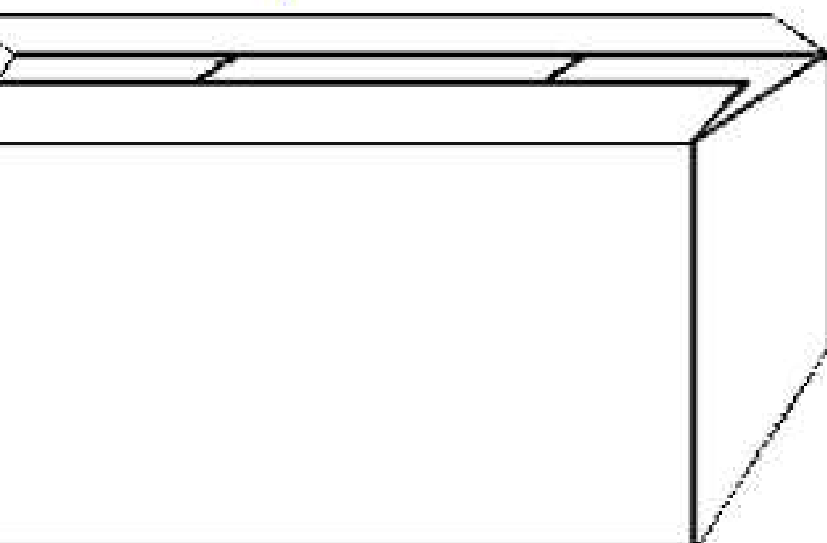

### DATI TECNICI - DATES TECHNIQUES - TECHNICAL DATA

Potenza elettrica Puissance électrique Electric power	Capacità aspirante Capacité d'aspiration Suction power	Capacità secchio capacité de seau Ability bucket	Filtro Hepa Filtre Hepa Hepa filter
1600 W	210 watt	1,3 L	Si - Oui - Yes