

+

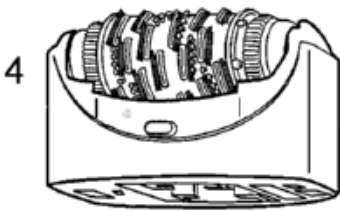

(40 tweezers)

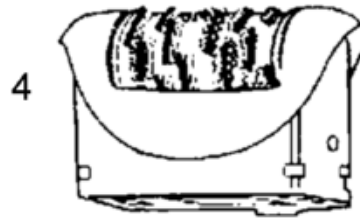

(20 tweezers, 81465100)

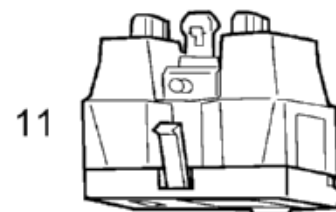
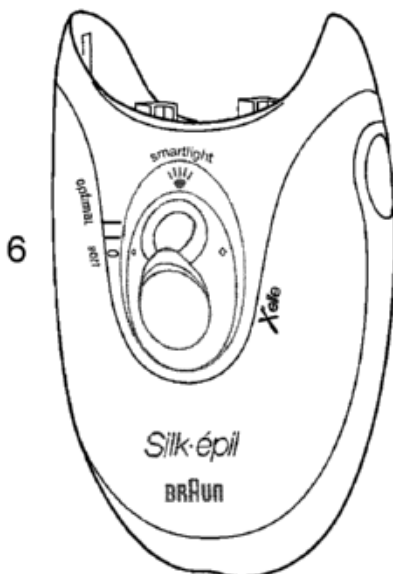
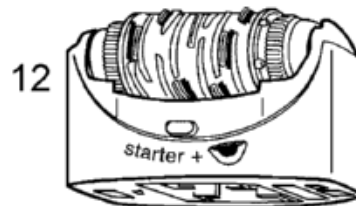
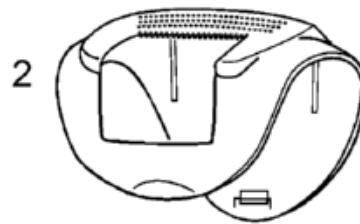
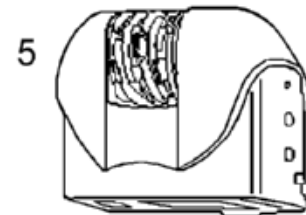



14

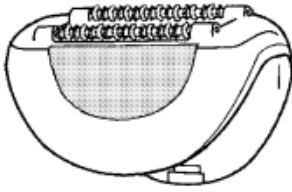

15

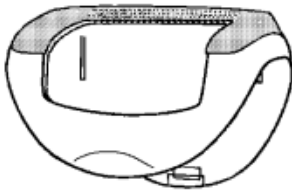

16



17

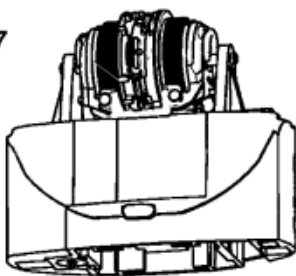

410



7

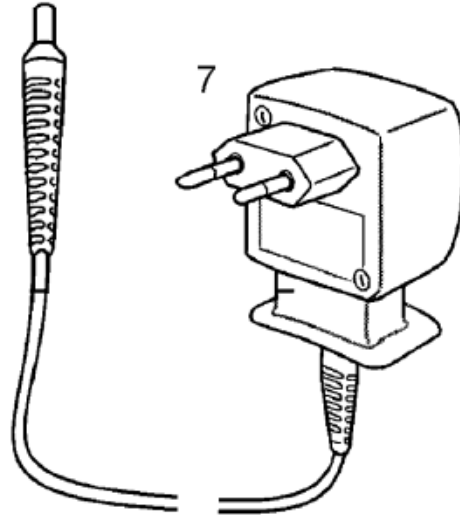

13

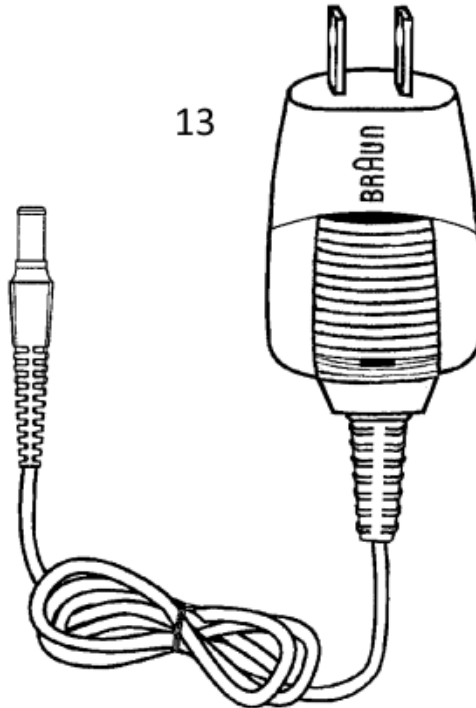

13

